

STRATOS S210 Series

S210-X12RS

**Ultra-Socket High Memory
1U Rackmount Server**

User's Guide

Version: 1.0

Conventions

Several different typographic conventions are used throughout this manual. Refer to the following examples for common usage.

Bold type face denotes menu items, buttons and application names.

Italic type face denotes references to other sections, and the names of the folders, menus, programs, and files.

<Enter> type face denotes keyboard keys.



WARNING!

Warning information appears before the text it references and should not be ignored as the content may prevent damage to the device.



CAUTION!

CAUTIONS APPEAR BEFORE THE TEXT IT REFERENCES, SIMILAR TO NOTES AND WARNINGS. CAUTIONS, HOWEVER, APPEAR IN CAPITAL LETTERS AND CONTAIN VITAL HEALTH AND SAFETY INFORMATION.



Important:

Indicates information that is important to know for the proper completion of a procedure, choice of an option, or completing a task.



Note:

Highlights general or useful information and tips.

Acronyms

TERM	DEFINITION
A/D	Analog to Digital
ACPI	Advanced Configuration and Power Interface
ASF	Alerting Standard Forum
Asserted	Active-high (positive true) signals are asserted when in the high electrical state (near power potential). Active-low (negative true) signals are asserted when in the low electrical state (near ground potential).
BIOS	Basic Input/Output System
BIST	Built-In Self Test
BMC	At the heart of the IPMI architecture is a microcontroller called the Baseboard management controller (BMC)
Bridge	Circuitry connecting one computer bus to another, allowing an agent on one to access the other
BSP	Bootstrap processor
Byte	8-bit quantity
CLI	Command Line Interface
CMOS	In terms of this specification, this describes the PC-AT compatible region of battery-backed 128 bytes of memory, which normally resides on the baseboard
CPU	Central Processing Unit

Deasserted	A signal is deasserted when in the inactive state. Active-low signal names have “_L” appended to the end of the signal mnemonic. Active-high signal names have no “_L” suffix. To reduce confusion when referring to active-high and active-low signals, the terms one/zero, high/low, and true/false are not used when describing signal states.
DTC	Data Transfer Controller
EEPROM	Electrically Erasable Programmable Read-Only Memory
EMP	Emergency Management Port
FRU	Field Replaceable Unit
GB	1024 MB.
GPIO	General Purpose Input/Out
HSC	Hot-Swap Controller
Hz	Hertz (1 cycle/second)
I ² C	Inter-Integrated Circuit bus
IANA	Internet Assigned Numbers Authority
IBF	Input buffer
ICH	I/O Controller Hub
ICMB	Intelligent Chassis Management Bus
IERR	Internal Error
IP	Internet Protocol
IPMB	Intelligent Platform Management Bus

IPMI	Intelligent Platform Management Interface
ITP	In-Target Probe
KB	1024 bytes.
KCS	Keyboard Controller Style
KVM	Keyboard, Video, Mouse
LAN	Local Area Network
LCD	Liquid Crystal Display
LCT	Lower Critical Threshold
LED	Light Emitting Diode
LNCT	Lower Non-Critical Threshold
LNRT	Lower Non-Recoverable Threshold
LPC	Low Pin Count
LSI	Large Scale Integration
LUN	Logical Unit Number
MAC	Media Access Control
MB	1024 KB
MD2	Message Digest 2 – Hashing Algorithm
MD5	Message Digest 5 – Hashing Algorithm – Higher Security
Ms	Milliseconds
Mux	Multiplexer
NIC	Network Interface Card
NMI	Nonmaskable Interrupt

NM	Node Management
OBF	Output buffer
OEM	Original Equipment Manufacturer
Ohm	Unit of electrical resistance
PDB	Power Distribution Board
PEF	Platform Event Filtering
PEP	Platform Event Paging
PERR	Parity Error
POH	Power-On Hours
POST	Power-On Self Test
PWM	Pulse Width Modulation
RAC	Remote Access Card
RAM	Random Access Memory
RMCP	Remote Management Control Protocol
ROM	Read Only Memory
RTC	Real-Time Clock. Component of the chipset on the baseboard.
RTOS	Real Time Operation System
SCI	Serial Communication Interface
SDC	SCSI Daughter Card
SDR	Sensor Data Record
SEEPROM	Serial Electrically Erasable Programmable Read-Only Memory

SEL	System Event Log
SERR	System Error
SMBus	A two-wire interface based on the I ² C protocol. The SMBus is a low-speed bus that provides positive addressing for devices, as well as bus arbitration
SMI	Server Management Interrupt. SMI is the highest priority nonmaskable interrupt
SMM	Server Management Mode
SMS	Server Management Software
SNMP	Simple Network Management Protocol
SOL	Serial Over LAN
UART	Universal Asynchronous Receiver/Transmitter
UCT	Upper Critical Threshold
UDP	User Datagram Protocol
UNCT	Upper Non-Critical Threshold
UNRT	Upper Non-Recoverable Threshold
WDT	Watchdog Timer
Word	16-bit quantity

Safety Information

Important Safety Instructions

Read all caution and safety statements in this document before performing any of the instructions.

Warnings

Heed safety instructions: Before working with the server, whether using this manual or any other resource as a reference, pay close attention to the safety instructions. Adhere to the assembly instructions in this manual to ensure and maintain compliance with existing product certifications and approvals. Use only the described, regulated components specified in this manual. Use of other products / components will void the UL listing and other regulatory approvals of the product and will most likely result in non-compliance with product regulations in the region(s) in which the product is sold.

System power on/off: The power button DOES NOT turn off the system AC power. To remove power from system, you must unplug the AC power cord from the wall outlet. Make sure the AC power cord is unplugged before opening the chassis, adding, or removing any components.

Hazardous conditions, devices and cables: Hazardous electrical conditions may be present on power, telephone, and communication cables. Turn off the server and disconnect the power cord, telecommunications systems, networks, and

modems attached to the server before opening it. Otherwise, personal injury or equipment damage can result.

Electrostatic discharge (ESD) and ESD protection: ESD can damage drives, boards, and other parts. We recommend that you perform all procedures in this chapter only at an ESD workstation. If one is not available, provide some ESD protection by wearing an antistatic wrist strap attached to chassis ground any unpainted metal surface on the server when handling parts.

ESD and handling boards: Always handle boards carefully. They can be extremely sensitive to electrostatic discharge (ESD). Hold boards only by their edges. After removing a board from its protective wrapper or from the server, place the board component side up on a grounded, static free surface. Use a conductive foam pad if available but not the board wrapper. Do not slide board over any surface.

Installing or removing jumpers: A jumper is a small plastic encased conductor that slips over two jumper pins. Some jumpers have a small tab on top that can be gripped with fingertips or with a pair of fine needle nosed pliers. If the jumpers do not have such a tab, take care when using needle nosed pliers to remove or install a jumper; grip the narrow sides of the jumper with the pliers, never the wide sides. Gripping the wide sides can damage the contacts inside the jumper, causing intermittent problems with the function controlled by that jumper. Take care to grip with, but not squeeze, the pliers or other tool used to remove a jumper, or the pins on the board may bend or break.

Revision History

Refer to the table below for the updates made to this manual.

DATE	CHAPTER	UPDATES
3/11/14	Specification	Ivy-Bridge platform support
	BIOS	Adding iSCSI and other sections
	BMC	Adding SNMP and Quanta SMASH

Copyright

Copyright © 2014 Quanta Computer Inc. This publication, including all photographs, illustrations and software, is protected under international copyright laws, with all rights reserved. Neither this manual, nor any of the material contained herein, may be reproduced without the express written consent of the manufacturer. All trademarks and logos are copyrights of their respective owners.

Version 1.0.2 3/11/14

Disclaimer

The information in this document is subject to change without notice. The manufacturer makes no representations or warran-

ties with respect to the contents hereof and specifically disclaims any implied warranties of merchantability or fitness for any particular purpose. Furthermore, the manufacturer reserves the right to revise this publication and to make changes from time to time in the content hereof without obligation of the manufacturer to notify any person of such revision or changes.

For the latest information and updates please refer to www.QuantaQCT.com

All the illustrations in this technical guide are for reference only and are subject to change without prior notice.

About the Server

Chapter 1

1.1 Introduction

This manual is written for system technicians who are responsible for troubleshooting, upgrading, and repairing the server chassis. This document provides an overview of the hardware features of the chassis, troubleshooting information, and instructions on how to add and replace components of the multi-node server series. The document also provides information on the BIOS, and Baseboard Management Controller (BMC).

For the latest version of this manual, see www.QauntaQCT.com.

System Features

The system comprises a 1U/28.66" long chassis using 16.5" x 19.18" mainboard. The major components are featured as follows:

- **Chipset:** Intel® C602 series, upgradeable ROM kit support.
- **Processors (x2):** Intel® Xeon processor E5-2600 / E5-2600 v2 product family.
- **PCI Express:** (1) PCIe x16 G3 Low profile riser slot, (1) PCIe x8 G3 Network Mezzanine slot, (1) PCIe x8 G3 SAS/RAID Mezzanine slot.
- **Memory:** Up to twenty-four DIMM slots are available. DDR3 800/1066/1333/1600/1866 MHz RDIMM/LR-DIMM memory is supported.



Note:

A second processor must be installed (in processor slot 2) to activate the expansion slot and to allow the mezzanine card in there to function properly.



Note:

Expansion cards described in the document are optional components.

- **Storage:** Up to ten 2.5" SATA/SAS hot-plug drives or four 3.5" SATA/SAS hot-plug drives. One SATADOM is optional.
- **Network:** Intel® Powerville I350GbE RJ45 or Intel® Twinville X540 10G BASE T RJ45 dual-port on board.

Table 1-1: Specification

Chassis type	1U Chassis
--------------	------------

Table 1-1: Specification (Continued)

Size (L x W x H)	<ul style="list-style-type: none"> ● 728.0 mm x 438.0 mm x 43.2 mm ● 28.6" x 17.2" x 1.7"
MB factor (W x L)	<ul style="list-style-type: none"> ● 487.17 mm x 419.1 mm ● 19.18" x 16.5"
Processor	(2) Intel® Xeon® processor E5-2600/ E5-2600 V2 family, up to 130W
Chipset	Intel® C602 (Patsburg A)
SAS Controller	<p>Intel® SAS controller</p> <ul style="list-style-type: none"> ● Intel® C602 (Patsburg A) upgrade ROM #1 (optional) ● Intel® C602 (Patsburg A) upgrade ROM #2 (optional) ● Intel® C602 (Patsburg A) upgrade ROM #5 (optional) ● Intel® C602 (Patsburg A) upgrade ROM #6 (optional) <p>or</p> <p>LSI SAS controller</p> <ul style="list-style-type: none"> ● Quanta LSISAS 2008 Mezzanine card (optional) ● Quanta LSISAS 2108 Mezzanine card (optional) ● Quanta LSISAS 2208 Mezzanine card (optional) ● Quanta LSISAS 2308 Mezzanine card (optional)

Table 1-1: Specification (Continued)

System Memory	<ul style="list-style-type: none"> ● (24) DDR3 800/1066/1333/1600/1866 MHz ● ECC RDIMM/LR-DIMM slots up to 768 GB
Storage	<ul style="list-style-type: none"> ● (10) 2.5" SATA/SAS hot-plug drives, or ● (4) 3.5" SATA/SAS hot-plug drives ● (1) SATADOM (optional)
HDD Backplane	1 to 1 or expander
PCI Expansion Slot	<ul style="list-style-type: none"> ● (1) PCIe x16 G3 low profile riser slot ● (1) PCIe x8 G3 10GbE SFP+ Mezzanine slot ● (1) PCIe x8 G3 Quanta LSISAS/RAID Mezzanine slot

Table 1-1: Specification (Continued)

<p>Software RAID Options</p>	<p>Intel® SW RAID</p> <ul style="list-style-type: none"> ● Intel® RSTe SATA RAID 0/1/10 (AHCI HDD) ● Intel® C602 (Patsburg A) upgrade ROM #1 RAID 0/1/10 for SCU (optional) ● Intel® C602 (Patsburg A) upgrade ROM #2 RAID 0/1/10/5 for SCU (optional) ● Intel® C602 (Patsburg A) upgrade ROM #5 RAID 0/1/10 for SCU (optional) ● Intel® C602 (Patsburg A) upgrade ROM #6 RAID 0/1/10/5 for SCU (optional) ● Intel® C602 (Patsburg A) upgrade ROM #9 SATA RAID 0/1/10/5 for SCU (optional) <p>or</p> <p>LSI SW RAID</p> <ul style="list-style-type: none"> ● Quanta LSISAS 2008 mezzanine card for RAID 0/1/10 (optional) ● Quanta LSISAS 2308 mezzanine card for RAID 0/1/10 (optional)
<p>Hardware RAID Options</p>	<ul style="list-style-type: none"> ● Quanta LSISAS2208 PD-32 mezzanine card for RAID 0/1/10/5 (optional) ● Quanta LSISAS2208 PD-32 mezzanine card + LSI RAID 6 Key for RAID 0/1/10/5/6/50/60 (optional)

Table 1-1: Specification (Continued)

<p>Network Interface</p>	<ul style="list-style-type: none"> ● (2) Intel® Powerville I350 GbE RJ45 ports, or ● (2) Intel® Twinville X540 10G BASE T RJ45 ports
<p>Management Port</p>	<p>(1) Dedicated GbE RJ45 management port</p>
<p>Integrated Graphics BMC</p>	<p>Aspeed AST2300 8MB DDR3 Video memory</p>
<p>Rear I/O Interface</p>	<ul style="list-style-type: none"> ● (2) USB 2.0 ports ● (1) VGA port ● (1) RS232 serial Port ● (2) GbE or 10G BASE-T RJ45 ports ● (1) GbE RJ45 management port ● (1) ID button with LED
<p>Power Supply</p>	<ul style="list-style-type: none"> ● (1) 750W high efficiency PSU, 100-240VAC 50/60Hz ● (1) 750W high efficiency redundant PSU, 100-240VAC 50/60Hz (optional)
<p>TPM</p>	<p>Yes (optional)</p>
<p>RoHS</p>	<p>Yes</p>
<p>Systems Management</p>	<ul style="list-style-type: none"> ● IPMI v2.0 Compliant ● On board "KVM over IP" support

Package Contents

The following list includes the package components:

- (1) 1U chassis system
- (1) Mainboard modules
- (2) Processor heatsinks
- (1) Power supply
- (1) Power cord (Optional)
- (1) CD (user manual included)
- (1) Rail kit

1.2 A Tour of the System

The system is available as a 2.5" or a 3.5" form factor. The following illustrations show the major component parts of these two variants.

2.5" HDD System

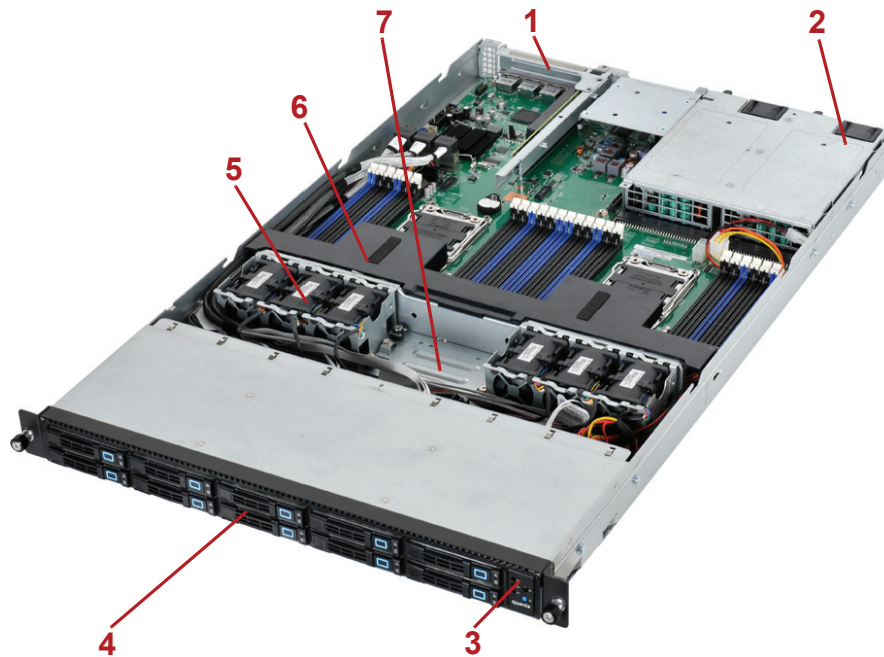

Table 1-2: 2.5" HDD System Component Overview

NO.	ITEM	DESCRIPTION
1	Riser Assembly	(1) PCIe x16 G3 low profile riser slot (1) PCIe x8 G3 10GbE SFP+ Mezzanine slot (1) PCIe x8 G3 Quanta LSI SAS/RAID Mezzanine slot
2	Hot-Swap PSU	(2) Power supply units
3	Front Panel	Control and LED panel for system status
4	2.5" Hard Drives	(10) 2.5" hard disk drives (HDD)
5	System Fan	(6) Fan module assembly
6	Air Duct	Maintains proper airflow throughout system
7	iBBU holder	Backup battery unit for mezzanine expansion card

Figure 1-1. 2.5" HDD System Component Overview

3.5" HDD System

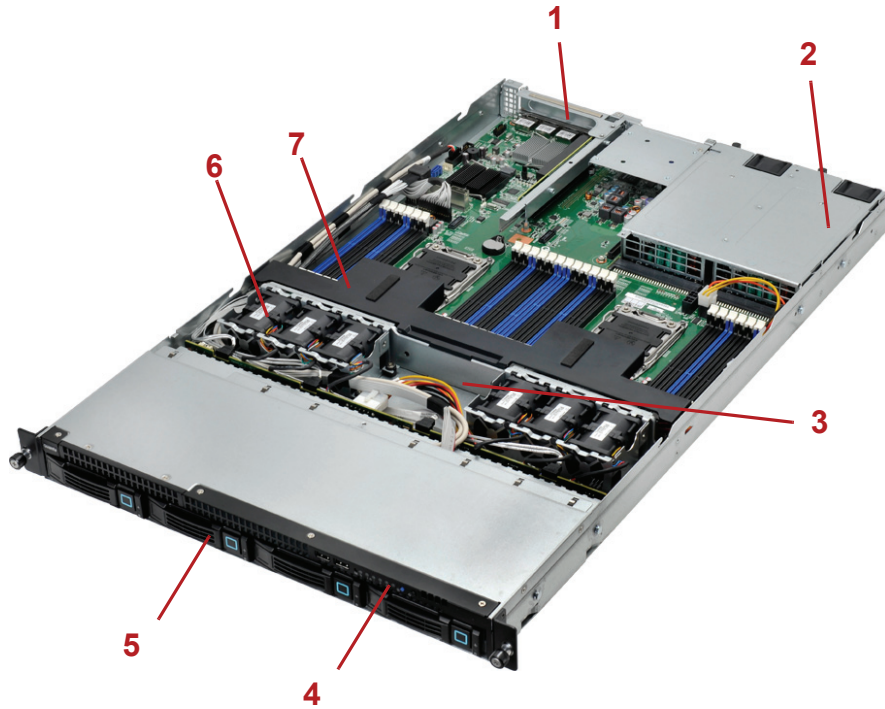

Table 1-3: 3.5" HDD System Component Description

No.	ITEM	DESCRIPTION
1.	Riser Assembly	(1) PCIe x16 G3 low profile riser slot (1) PCIe x8 G3 10GbE SFP+ Mezzanine slot (1) PCIe x8 G3 Quanta LSISAS/RAID Mezzanine slot
2.	Hot-Swap PSU	(2) Power supply units
3.	Front Panel	Control and LED panel for system status
4.	iBBU holder	Backup battery unit for mezzanine expansion card
5.	3.5 Hard Drives	(4) 3.5" hard disk drives (HDD)
6.	System Fan	(6) Fan module assembly
7.	Air Duct	Maintains proper airflow throughout system

Figure 1-2. 3.5" HDD System Component Description

3.5" HDD System Front Features

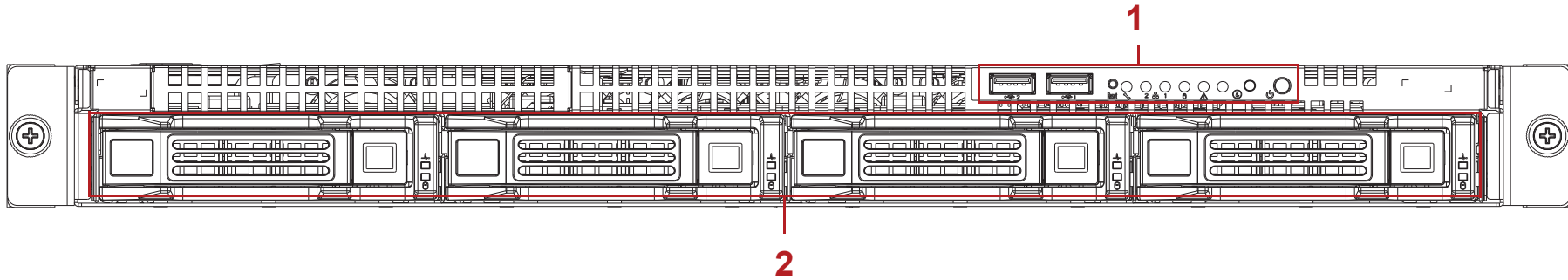

Figure 1-3. 3.5" HDD System Front Features

3.5" HDD System Front Panel Definition

Table 1-4: 3.5" HDD Front Panel Definition

ITEM	NAME	DESCRIPTION
1	Control Panel	Connect USB devices to these ports
2	HDD Bays	Insert HDDs here.

3.5" HDD System Front Control Panel

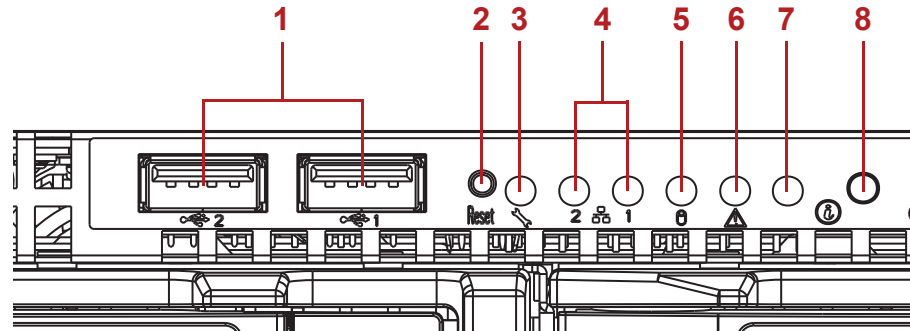

Table 1-5: 3.5" HDD System LED Function and Behavior

ITEM	ICON	NAME	DESCRIPTION
1		Front USB ports	Connect USB devices to these ports

Table 1-5: 3.5" HDD System LED Function and Behavior (Continued)





ITEM	ICON	NAME	DESCRIPTION
2		Reset Button with LED	Base system On Push button to Reset system
3		MGMT LED	Green On, link Green Blinking, LAN access
4		LAN 2/1 LED	Green On, link Green Blinking, LAN access
5		HDD Activity LED	Green Blinking, HDD access Off, no access
6		Event LED	Amber Blinking Critical failure: fan, voltage, temperature state Non-critical failure: fan, voltage, temperature state, CPU, thermal trip Off SEL cleared, DC Off, last pending warning/error de-asserted
7		ID Button with LED	Blue On Selected unit ID Off No ID requested

Table 1-5: 3.5" HDD System LED Function and Behavior (Continued)

ITEM	ICON	NAME	DESCRIPTION
8		Power button with LED	Green On Off System off Turn system on / off.

2.5" HDD System Front Features

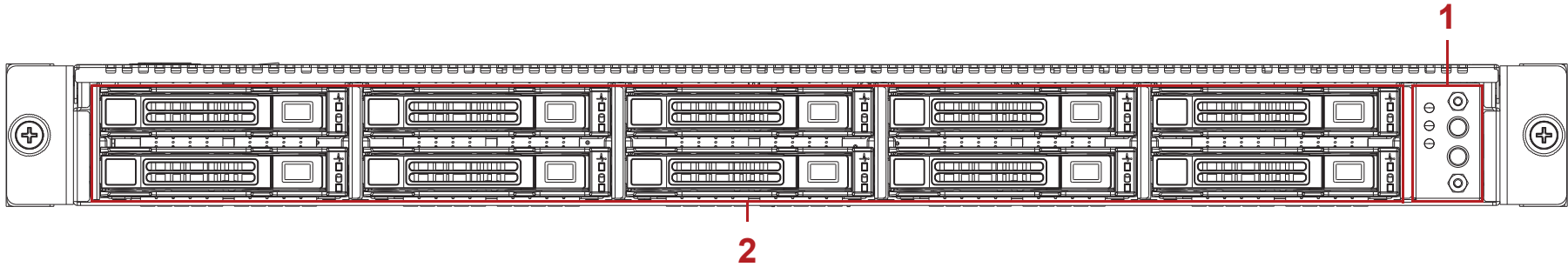

Figure 1-4. 2.5" HDD System Front Features

2.5" HDD System Front Panel Definition

Table 1-6: 2.5" HDD Front Panel Definition

ITEM	NAME	DESCRIPTION
1	Control Panel	Connect USB devices to these ports
2	HDD Bays	Insert HDDs here.

2.5" HDD System Front Control Panel

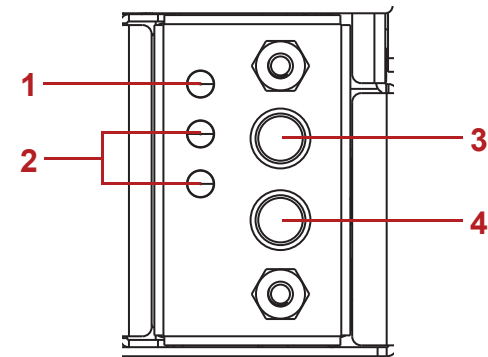





Figure 1-5. Control Panel

Table 1-7: 2.5" HDD LED Function and Behavior

ITEM	ICON	NAME	DESCRIPTION
1		Event LED	Amber Blinking Critical failure: fan, voltage, temperature state Non-critical failure: fan, voltage, temperature state, CPU, thermal trip Off SEL cleared, DC Off, last pending warning/error de-asserted
2		LAN1/2 LED	Green ON, link Green Blinking, LAN access
3		Power Button with LED	Green On Off System off
			Turn system on / off
4		ID button with LED	Blue On Selected unit ID Off No ID requested

System HDD Introduction

This system is available in two form factors, 2.5" HDD and 3.5" HDD.

2.5" Hard Disk Drive Configuration

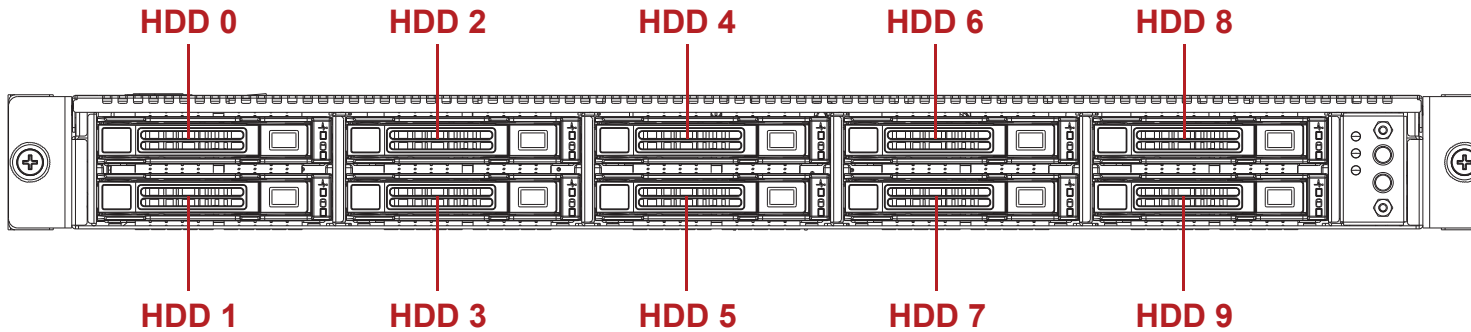

Figure 1-6. 2.5" HDD Configuration

3.5" Hard Disk Drive Configuration

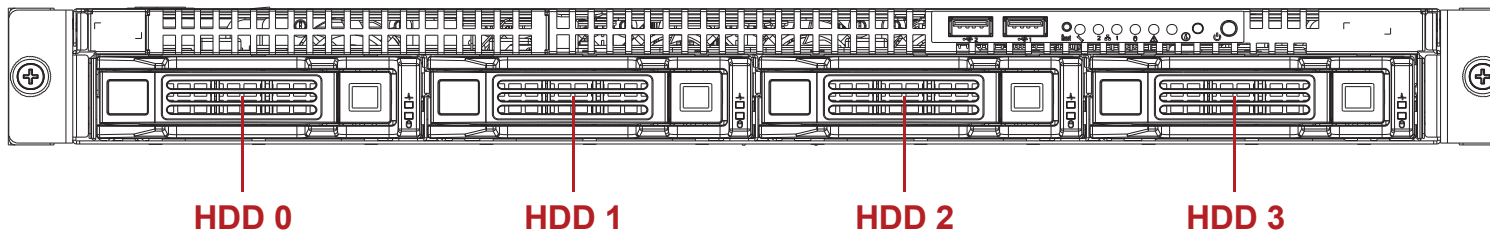

Figure 1-7. 3.5" HDD Configuration

System Rear Features

System Rear View

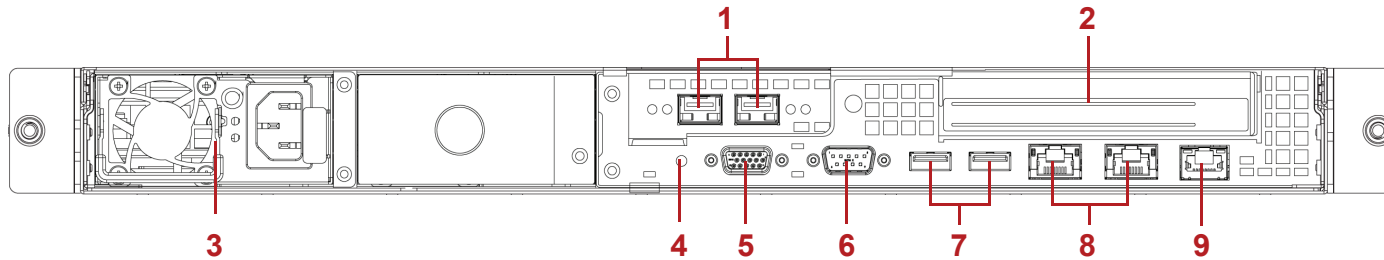

Figure 1-8. I/O Features (shown with ports on Mezzanine card)

Table 1-8: System I/O Features

ITEM	FEATURE	DESCRIPTION
1	10GbE SFP+ Port	Optional
2	PCIe Card	PCIe x16 G3 card
3	PSU	Power supply unit Left: PSU1 Right: PSU0
4	ID button	Press this to illuminate the ID LED on the front panel
5	VGA port	Connect a monitor to this port
6	Console port	Connect a serial cable to this port
7	USB port	(2) USB 2.0 ports

Table 1-8: System I/O Features (Continued)

ITEM	FEATURE	DESCRIPTION
8	GbE (or 10GbE) LAN port	Connect this to the data network
9	Dedicated Management LAN Port	Connect this to a network monitoring station



Note:

The system supports single and redundant PSU. Redundant PSU is optional.

System I/O LED Description

Rear I/O LED Description

Table 1-9: Rear side LED Function and Behavior (1G LAN)

ICON	NAME		COLOR	CONDITION	DESCRIPTION
	Identification LED		Blue	ON	Unit selected for identification
	Identification LED		Blue	OFF	No identification requested
	LAN1 LED (Right)	Link/Act	Green	On	LAN Link
				Blinking	LAN access (off when there is traffic)
				OFF	Disconnect
	LAN1 LED (Right)	Speed	Green	ON	Link speed is 100Mbps/sec
			Amber	ON	Link speed is 1000Mbps/sec
			--	OFF	OFF, link speed is 10Mbps/sec
	LAN2 LED (Left)	Link/Act	Green	On	LAN Link
				Blinking	LAN access (off when there is traffic)
				OFF	Disconnect
	LAN2 LED (Left)	Speed	Green	ON	Link speed is 100Mbps/sec
			Amber	ON	Link speed is 1000Mbps/sec
			--	OFF	OFF, link speed is 10Mbps/sec

Table 1-9: Rear side LED Function and Behavior (1G LAN) (Continued)

ICON	NAME		COLOR	CONDITION	DESCRIPTION
	Service Port (LAN 3) LED	Link/Act	Green	On	LAN Link
				Blinking	LAN access (off when there is traffic)
				OFF	Disconnect
		Speed	Green	ON	Link speed is 10/100/1000Mbps/sec

Table 1-10: Rear side LED Function and Behavior (10G LAN)

ICON	NAME		COLOR	CONDITION	DESCRIPTION
	Identification LED		Blue	ON	Unit selected for identification
				OFF	No identification requested
	LAN1 LED (Right)	Link/Act	Green	On	LAN Link
				Blinking	LAN access (off when there is traffic)
				OFF	Disconnect
	Speed	Blue	ON	Link speed is 10Gbits/sec	
		Amber	ON	Link speed is 1Gbits/sec	
		--	OFF	Link speed is 10/100Mbps/sec	

Table 1-10: Rear side LED Function and Behavior (10G LAN) (Continued)



ICON	NAME		COLOR	CONDITION	DESCRIPTION
	LAN2 LED (Left)	Link/Act	Green	On	LAN Link
				Blinking	LAN access (off when there is traffic)
				OFF	Disconnect
		Speed	Blue	ON	Link speed is 10Gbits/sec
			Amber	ON	Link speed is 1Gbits/sec
			--	OFF	Link speed is 10/100Mbps/sec
	Service Port (LAN 3) LED	Link/Act	Green	On	LAN Link
				Blinking	LAN access (off when there is traffic)
				OFF	Disconnect
		Speed	Green	ON	Link speed is 10/100/1000Mbps/sec
				OFF	Disconnect

Installation and Assembly Safety Instructions

Chapter 2

2.1 Installation Assembly Safety Instructions

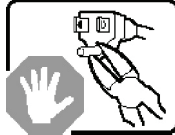
Guidelines

	<p>The power supply in this product contains no user-serviceable parts.</p> <p>Refer servicing only to qualified personnel.</p>
	<p>Do not attempt to modify or use the supplied AC power cord if it is not the exact type required. A product with more than one power supply will have a separate AC power cord for each supply.</p>
	<p>The power button on the system does not turn off system AC power.</p> <p>To remove AC power from the system, you must unplug each AC power cord from the wall outlet or power supply.</p> <p>The power cord(s) is considered the disconnect device to the main (AC) power. The socket outlet that the system plugs into shall be installed near the equipment and shall be easily accessible.</p>



SAFETY STEPS: Whenever you remove the chassis covers to access the inside of the system, follow these steps:

1. Turn off all peripheral devices connected to the system.
2. Turn off the system by pressing the power button.
3. Unplug all AC power cords from the system or from wall outlets.
4. Label and disconnect all cables connected to I/O connectors or ports on the back of the system.
5. Provide some electrostatic discharge (ESD) protection by wearing an antistatic wrist strap attached to chassis ground of the system-any unpainted metal surface-when handling components.
6. Do not operate the system with the chassis covers removed.

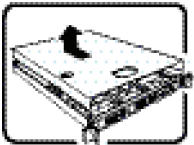

After you have completed the six SAFETY steps above, you can remove the system covers. To do this:

1. Unlock and remove the padlock from the back of the system if a padlock has been installed.
2. Remove and save all screws from the covers.
3. Remove the cover(s).

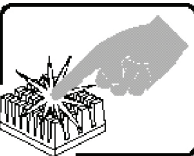

A microprocessor and heat sink may be hot if the system has been running. Also, there may be sharp pins and edges on some board and chassis parts. Contact should be made with care. Consider wearing protective gloves.

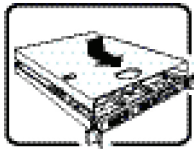

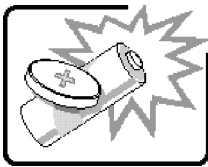

For proper cooling and airflow, always reinstall the chassis covers before turning on the system. Operating the system without the covers in place can damage system parts. To install the covers:

1. Check first to make sure you have not left loose tools or parts inside the system.
2. Check that cables, add-in cards, and other components are properly installed.
3. Attach the covers to the chassis with the screws removed earlier, and tighten them firmly.
4. Insert and lock the padlock to the system to prevent unauthorized access inside the system.
5. Connect all external cables and the AC power cord(s) to the system.

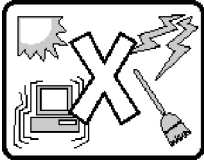

Danger of explosion if the battery is incorrectly replaced. Replace only with the same or equivalent type recommended by the equipment manufacturer. Dispose of used batteries according to manufacturer's instructions.

	<p>The system is designed to operate in a typical office environment.</p> <p>Choose a site that is:</p> <ul style="list-style-type: none"> • Clean and free of airborne particles (other than normal room dust). • Well ventilated and away from sources of heat including direct sunlight. • Away from sources of vibration or physical shock. • Isolated from strong electromagnetic fields produced by electrical devices. • In regions that are susceptible to electrical storms, we recommend you plug your system into a surge suppressor and disconnect telecommunication lines to your modem during an electrical storm. • Provided with a properly grounded wall outlet. • Provided with sufficient space to access the power supply cord(s), because they serve as the product's main power disconnect.
	<p>The server system is safety certified as rack-mounted equipment for use in a server room or computer room, using the customer rack kit.</p> <p>The rail racks are designed to carry only the weight of the server system. Do not place additional load onto any rail-mounted equipment.</p> <p>System rack kits are intended to be installed in a rack by trained service technicians.</p>
	<p>Heavy object. Indicates two people are required to safely handle the system.</p>

Safety Information

Chapter 3

3.1 Server Safety Information

To reduce the risk of bodily injury, electrical shock, fire, and equipment damage, read this document and observe all warnings and precautions in this guide before installing or maintaining your server product.

In the event of a conflict between the information in this document and information provided with the product or on the website for a particular product, the product documentation takes precedence.

Your server should be integrated and serviced only by technically qualified persons.

You must adhere to the guidelines in this guide and the assembly instructions in your server manuals to ensure and maintain compliance with existing product certifications and approvals. Use only the described, regulated components specified in this guide. Use of other products / components will void the UL Listing and other regulatory approvals of the product, and may result in noncompliance with product regulations in the region(s) in which the product is sold.

Safety Warnings and Cautions

To avoid personal injury or property damage, before you begin installing the product, read, observe, and adhere to all of the following safety instructions and information. The following safety symbols may be used throughout the documentation and may be marked on the product and / or the product packaging.

Table 9-1: Safety Warning and Cautions









CAUTION	Indicates the presence of a hazard that may cause minor personal injury or property damage if the CAUTION is ignored.
WARNING	Indicates the presence of a hazard that may result in serious personal injury if the WARNING is ignored.
	Indicates potential hazard if indicated information is ignored.
	Indicates shock hazards that result in serious injury or death if safety instructions are not followed.
	Indicates hot components or surfaces.
	Indicates do not touch fan blades, may result in injury.

Table 9-1: Safety Warning and Cautions

	Indicates to unplug all AC power cord(s) to disconnect AC power.
	Please recycle battery.
	The rail racks are designed to carry only the weight of the server system. Do not use rail-mounted equipment as a workspace. Do not place additional load onto any rail-mounted equipment.
	Indicates two people are required to safely handle the system.
	<p>Restricted Access Location: The server is intended for installation only in a Server Room or Computer Room where both these conditions apply:</p> <ul style="list-style-type: none"> ■ access can only be gained by SERVICE PERSONS or by USERS who have been instructed about the reasons for the restrictions applied to the location and about any precautions that shall be taken; and ■ access is through the use of a TOOL or lock and key, or other means of security, and is controlled by the authority responsible for the location.

Intended Application Uses

This product was evaluated as Information Technology Equipment (ITE), which may be installed in offices, schools, computer rooms, and similar commercial type locations. The suitability of

this product for other product categories and environments (such as medical, industrial, residential, alarm systems, and test equipment), other than an ITE application, may require further evaluation.

Site Selection

The system is designed to operate in a typical office environment. Choose a site that is:

- Clean, dry, and free of airborne particles (other than normal room dust).
- Well-ventilated and away from sources of heat including direct sunlight and radiators.
- Away from sources of vibration or physical shock.
- Isolated from strong electromagnetic fields produced by electrical devices.
- In regions that are susceptible to electrical storms, we recommend you plug your system into a surge suppressor and disconnect telecommunication lines to your modem during an electrical storm.
- Provided with a properly grounded wall outlet.
- Provided with sufficient space to access the power supply cord(s), because they serve as the product's main power disconnect.
- Provided with either two independent AC power sources or two independent phases from a single source.

Equipment Handling Practices

Reduce the risk of personal injury or equipment damage:

- Conform to local occupational health and safety requirements when moving and lifting equipment.
- Use mechanical assistance or other suitable assistance when moving and lifting equipment.
- To reduce the weight for easier handling, remove any easily detachable components.

Power and Electrical Warnings



CAUTION!

THE POWER BUTTON, INDICATED BY THE STAND-BY POWER MARKING, DOES NOT COMPLETELY TURN OFF THE SYSTEM AC POWER, 5V STANDBY POWER IS ACTIVE WHENEVER THE SYSTEM IS PLUGGED IN. TO REMOVE POWER FROM SYSTEM, YOU MUST UNPLUG THE AC POWER CORD FROM THE WALL OUTLET. YOUR SYSTEM MAY USE MORE THAN ONE AC POWER CORD. MAKE SURE ALL AC POWER CORDS ARE UNPLUGGED. MAKE SURE THE AC POWER CORD(S) IS / ARE UNPLUGGED BEFORE YOU OPEN THE CHASSIS, OR ADD OR REMOVE ANY NON HOT-PLUG COMPONENTS.



CAUTION!

DO NOT ATTEMPT TO MODIFY OR USE AN AC POWER CORD IF IT IS NOT THE EXACT TYPE REQUIRED. A SEPARATE AC CORD IS REQUIRED FOR EACH SYSTEM POWER SUPPLY.



CAUTION!

SOME POWER SUPPLIES IN SERVERS USE NEUTRAL POLE FUSING. TO AVOID RISK OF SHOCK USE CAUTION WHEN WORKING WITH POWER SUPPLIES THAT USE NEUTRAL POLE FUSING.



CAUTION!

SOME POWER SUPPLIES IN SERVERS USE NEUTRAL POLE FUSING. TO AVOID RISK OF SHOCK USE CAUTION WHEN WORKING WITH POWER SUPPLIES THAT USE NEUTRAL POLE FUSING.



CAUTION!

THE POWER SUPPLY IN THIS PRODUCT CONTAINS NO USER-SERVICEABLE PARTS. DO NOT OPEN THE POWER SUPPLY. HAZARDOUS VOLTAGE, CURRENT AND ENERGY LEVELS ARE PRESENT INSIDE THE POWER SUPPLY. RETURN TO MANUFACTURER FOR SERVICING.



CAUTION!

WHEN REPLACING A HOT-PLUG POWER SUPPLY, UNPLUG THE POWER CORD TO THE POWER SUPPLY BEING REPLACED BEFORE REMOVING IT FROM THE SERVER.



CAUTION!

TO AVOID RISK OF ELECTRIC SHOCK, TURN OFF THE SERVER AND DISCONNECT THE POWER CORD, TELECOMMUNICATIONS SYSTEMS, NETWORKS, AND MODEMS ATTACHED TO THE SERVER BEFORE OPENING IT.

Power Cord Warnings

If an AC power cord was not provided with your product, purchase one that is approved for use in your country.



CAUTION!

TO AVOID ELECTRICAL SHOCK OR FIRE, CHECK THE POWER CORD(S) THAT WILL BE USED WITH THE PRODUCT AS FOLLOWS:

- Do not attempt to modify or use the AC power cord(s) if they are not the exact type required to fit into the grounded electrical outlets.
- The power cord(s) must meet the following criteria:

The power cord must have an electrical rating that is greater than that of the electrical current rating marked on the product.



CAUTION!

THE POWER CORD MUST HAVE SAFETY GROUND PIN OR CONTACT THAT IS SUITABLE FOR THE ELECTRICAL OUTLET.



CAUTION!

THE POWER SUPPLY CORD(S) IS / ARE THE MAIN DISCONNECT DEVICE TO AC POWER. THE SOCKET OUTLET(S) MUST BE NEAR THE EQUIPMENT AND READILY ACCESSIBLE FOR DISCONNECTION.



CAUTION!

THE POWER SUPPLY CORD(S) MUST BE PLUGGED INTO SOCKET-OUTLET(S) THAT IS /ARE PROVIDED WITH A SUITABLE EARTH GROUND.

System Access Warnings



CAUTION!

TO AVOID PERSONAL INJURY OR PROPERTY DAMAGE, THE FOLLOWING SAFETY INSTRUCTIONS APPLY WHENEVER ACCESSING THE INSIDE OF THE PRODUCT:

- Turn off all peripheral devices connected to this product.
- Turn off the system by pressing the power button to off.
- Disconnect the AC power by unplugging all AC power cords from the system or wall outlet.
- Disconnect all cables and telecommunication lines that are connected to the system.
- Retain all screws or other fasteners when removing access cover(s). Upon completion of accessing inside the product, refasten access cover with original screws or fasteners.
- Do not access the inside of the power supply. There are no serviceable parts in the power supply. Return to manufacturer for servicing.
- Power down the server and disconnect all power cords before adding or replacing any non hot-plug component.

When replacing a hot-plug power supply, unplug the power cord to the power supply being replaced before removing the power supply from the server.



CAUTION!

IF THE SERVER HAS BEEN RUNNING, ANY INSTALLED PROCESSOR(S) AND HEAT SINK(S) MAY BE HOT.

**CAUTION!**

UNLESS YOU ARE ADDING OR REMOVING A HOT-PLUG COMPONENT, ALLOW THE SYSTEM TO COOL BEFORE OPENING THE COVERS. TO AVOID THE POSSIBILITY OF COMING INTO CONTACT WITH HOT COMPONENT(S) DURING A HOT-PLUG INSTALLATION, BE CAREFUL WHEN REMOVING OR INSTALLING THE HOT-PLUG COMPONENT(S).

**CAUTION!**

TO AVOID INJURY DO NOT CONTACT MOVING FAN BLADES. IF YOUR SYSTEM IS SUPPLIED WITH A GUARD OVER THE FAN, DO NOT OPERATE THE SYSTEM WITHOUT THE FAN GUARD IN PLACE.

Rack Mount Warnings

The following installation guidelines are required by UL for maintaining safety compliance when installing your system into a rack.

The equipment rack must be anchored to an unmovable support to prevent it from tipping when a server or piece of equipment is extended from it. The equipment rack must be installed according to the rack manufacturer's instructions.

Install equipment in the rack from the bottom up, with the heaviest equipment at the bottom of the rack.

Extend only one piece of equipment from the rack at a time.

You are responsible for installing a main power disconnect for the entire rack unit. This main disconnect must be readily accessible, and it must be labeled as controlling power to the entire unit, not just to the server(s).

To avoid risk of potential electric shock, a proper safety ground must be implemented for the rack and each piece of equipment installed in it.

Elevated Operating Ambient - If installed in a closed or multi-unit rack assembly, the operating ambient temperature of the rack environment may be greater than room ambient. Therefore, consideration should be given to installing the equipment in an environment compatible with the maximum ambient temperature (T_{ma}) specified by the manufacturer.

Reduced Air Flow - Installation of the equipment in a rack should be such that the amount of air flow required for safe operation of the equipment is not compromised.

Mechanical Loading - Mounting of the equipment in the rack should be such that a hazardous condition is not achieved due to uneven mechanical loading.

Circuit Overloading - Consideration should be given to the connection of the equipment to the supply circuit and the effect that overloading of the circuits might have on overcurrent protection and supply wiring. Appropriate consideration of equipment nameplate ratings should be used when addressing this concern.

Reliable Earthing - Reliable earthing of rack-mounted equipment should be maintained.

Particular attention should be given to supply connections other than direct connections to the branch circuit (e.g. use of power strips).

Electrostatic Discharge (ESD)



CAUTION!

ESD CAN DAMAGE DRIVES, BOARDS, AND OTHER PARTS. WE RECOMMEND THAT YOU PERFORM ALL PROCEDURES AT AN ESD WORKSTATION. IF ONE IS NOT AVAILABLE, PROVIDE SOME ESD PROTECTION BY WEARING AN ANTISTATIC WRIST STRAP ATTACHED TO CHASSIS GROUND -- ANY UNPAINTED METAL SURFACE -- ON YOUR SERVER WHEN HANDLING PARTS.

Always handle boards carefully. They can be extremely sensitive to ESD. Hold boards only by their edges. After removing a board from its protective wrapper or from the server, place the board component side up on a grounded, static free surface. Use a conductive foam pad if available but not the board wrapper. Do not slide board over any surface.

Other Hazards

Battery Replacement

**CAUTION!**

THERE IS THE DANGER OF EXPLOSION IF THE BATTERY IS INCORRECTLY REPLACED. WHEN REPLACING THE BATTERY, USE ONLY THE BATTERY RECOMMENDED BY THE EQUIPMENT MANUFACTURER.

**CAUTION!**

DISPOSE OF BATTERIES ACCORDING TO LOCAL ORDINANCES AND REGULATIONS.

**CAUTION!**

DO NOT ATTEMPT TO RECHARGE A BATTERY.

**CAUTION!**

DO NOT ATTEMPT TO DISASSEMBLE, PUNCTURE, OR OTHERWISE DAMAGE A BATTERY.

Cooling and Airflow

**CAUTION!**

CAREFULLY ROUTE CABLES AS DIRECTED TO MINIMIZE AIRFLOW BLOCKAGE AND COOLING PROBLEMS. FOR PROPER COOLING AND AIRFLOW, OPERATE THE SYSTEM ONLY WITH THE CHASSIS COVERS INSTALLED. OPERATING THE SYSTEM WITHOUT THE COVERS IN PLACE CAN DAMAGE SYSTEM PARTS. TO INSTALL THE COVERS:

- Check first to make sure you have not left loose tools or parts inside the system.
- Check that cables, add-in cards, and other components are properly installed.

Attach the covers to the chassis according to the product instructions.

Laser Peripherals or Devices

**CAUTION!**

TO AVOID RISK OF RADIATION EXPOSURE AND / OR PERSONAL INJURY:

- Do not open the enclosure of any laser peripheral or device.
- Laser peripherals or devices are not serviceable. Return to manufacturer for servicing.

Use certified and rated Laser Class I for Optical Transceiver product.

Regulatory and Compliance Information

Chapter 4

4.1 Product Regulatory Compliance Markings

This product is marked with the following Product Certification markings:

Table 10-1: Product Regulatory Compliance Markings

REGULATORY COMPLIANCE	REGION	MARKING
cULus Listing Marks	USA / Canada	
CE Mark	Europe	
FCC Marking (Class A)	USA	This device complies with Part 15 of the FCC Rules. Operation of this device is subject to the following two conditions: (1) This device may not cause harmful interference, and (2) This device must accept any interference received, including interference that may cause undesired operation.
VCCI Marking (Class A)	Japan	この装置は、クラス A 情報技術装置です。この装置を家庭環境で使用すると電波妨害を引き起こすことがあります。この場合には使用者が適切な対策を講ずるよう要求されることがあります。VCCI-A

Table 10-1: Product Regulatory Compliance Markings (Continued)

BSMI Certification Number & Class A Warning	Taiwan	 警告使用者： 這是甲類的資訊產品，在居住的環境中使用時，可能會造成射頻干擾，在這種情況下，使用者會被要求採取某些適當的對策
KCC	Korea	 A급 기기 (업무용 정보통신기기) 이 기기는 업무용으로 전자파적합등록을 한 기기이오니 판매자 또는 사용자는 이 점을 주의하시기 바라며, 만약 잘못판매 또는 구입하였을 때에는 가장 용으로 교환하시기 바랍니다.
GOST R Marking	Russia	

Table 10-1: Product Regulatory Compliance Markings (Continued)

ICES	Canada	<p>This Class A digital apparatus complies with Canadian ICES-003.</p> <p>Cet appareil numérique de la classe A est conforme à la norme NMB-003 du Canada.</p>
Recycling Package Mark	Other than China	

Electromagnetic Compatibility Notices

FCC Verification Statement (USA)

This device complies with Part 15 of the FCC Rules. Operation is subject to the following two conditions: (1) this device may not cause harmful interference, and (2) this device must accept any interference received, including interference that may cause undesired operation.

This equipment has been tested and found to comply with the limits for a Class A digital device, pursuant to Part 15 of the FCC Rules. These limits are designed to provide reasonable protection against harmful interference in a residential installation. This equipment generates, uses, and can radiate radio frequency energy and, if not installed and used in accordance with the instructions, may cause harmful interference to radio communications. However, there is no guarantee that interference will not occur in a particular installation. If this equipment does cause harmful interference to radio or television reception, which can be determined by turning the equipment off and on, the user is encouraged to try to correct the interference by one or more of the following measures:

- Reorient or relocate the receiving antenna.
- Increase the separation between the equipment and the receiver
- Connect the equipment to an outlet on a circuit other than the one to which the receiver is connected.

- Consult the dealer or an experienced radio/TV technician for help.

Any changes or modifications not expressly approved by the grantee of this device could void the user's authority to operate the equipment. The customer is responsible for ensuring compliance of the modified product.

Only peripherals (computer input/output devices, terminals, printers, etc.) that comply with FCC Class A or B limits may be attached to this computer product. Operation with noncompliant peripherals is likely to result in interference to radio and TV reception.

All cables used to connect to peripherals must be shielded and grounded. Operation with cables, connected to peripherals, that are not shielded and grounded may result in interference to radio and TV reception.

Europe (CE Declaration of Conformity)

This product has been tested in accordance too, and complies with the Low Voltage Directive (73/23/EEC) and EMC Directive (89/336/EEC). The product has been marked with the CE Mark to illustrate its compliance.

VCCI (Japan)

この装置は、情報処理装置等電波障害自主規制協議会（VCCI）の基準に基づくクラス A 情報技術装置です。この装置を家庭環境で使用すると電波妨害を引き起こすことがあります。この場合には使用者が適切な対策を講ずるよう要求されることがあります。

English translation of the notice above:

This is a Class A product based on the standard of the Voluntary Control Council for Interference (VCCI) from Information Technology Equipment. If this is used near a radio or television receiver in a domestic environment, it may cause radio interference. Install and use the equipment according to the instruction manual.

BSMI (Taiwan)

The BSMI Certification Marking and EMC warning is located on the outside rear area of the product.

警告使用者：
這是甲類的資訊產品，在居住的環境中使用時，可能會造成射頻干擾，在這種情況下，使用者會被要求採取某些適當的對策

KCC (Korea)

Korean Communications Commission (KCC) Class A Statement:

A급 기기 (업무용 정보통신기기)

이 기기는 업무용으로 전자파적합등록을 한 기기이오니 판매자 또는 사용자는 이 점을 주의하시기 바라며, 만약 잘못판매 또는 구입하였을 때에는 가정용으로 교환하시기 바랍니다.

Regulated Specified Components

To maintain the UL listing and compliance to other regulatory certifications and/or declarations, the following regulated components must be used and conditions adhered to. Interchanging or use of other component will void the UL listing and other product certifications and approvals.

Updated product information for configurations can be found on the site at the following URL:

www.quantaqct.com

If you do not have access to the Web address, please contact your local representative.

- Add-in cards: must have a printed wiring board flammability rating of minimum UL94V-1. Add-in cards containing external power connectors and/or lithium batteries must be UL recognized or UL listed. Any add-in card containing

modem telecommunication circuitry must be UL listed. In addition, the modem must have the appropriate telecommunications, safety, and EMC approvals for the region in which it is sold.

- Peripheral Storage Devices: must be UL recognized or UL listed accessory and TUV or VDE licensed. Maximum power rating of any one device is 19 watts. Total server configuration is not to exceed the maximum loading conditions of the power supply.

Restriction of Hazardous Substances (RoHS) Compliance

Quanta® Computer Inc. has a system in place to restrict the use of banned substances in accordance with the European Directive 2002/95/EC. Compliance is based on declaration that materials banned in the RoHS Directive are either (1) below all applicable threshold limits or (2) an approved / pending RoHS exemption applies.

RoHS implementation details are not fully defined and may change.

Threshold limits and banned substances are noted below:

- Quantity limit of 0.1% by mass (1000 PPM) for:
 - Lead
 - Mercury
 - Hexavalent Chromium

- Polybrominated Biphenyls Diphenyl Ethers (PBDE)
- Quantity limit of 0.01% by mass (100 PPM) for:
 - Cadmium

End of Life / Product Recycling

Product recycling and end-of-life take-back systems and requirements vary by country. Contact the retailer or distributor of this product for information about product recycling and / or take-back.